

# AMITEK

# SMART HOMES

ONE TOUCH TO EASY, SMART & SECURE LIFE STYLE

## SMART SWITCHES

An innovative step towards smart living



**Amitek** is India's Leading Brand for creation of sophisticated, energy-efficient, simple to use and reliable products like WiFi Touch Switch, Touch Switches, Hotel Room Automation Switches, Curtain Motor, Tubular Motor, TV Lift Motor, Swing Door Motor and Rolling Shutter Motor for use at residential, offices, retail, hospitality and public space. Fox Domotics is the solutions of choice for different types of "Smart System" . We have end to end solutions that can blend with high level functionality to enhance our living.

**Amitek** with its expertise in research and development had always focused its aim to engineer the sophisticated product developments which are called as 'Smart Systems'. With efforts of our team we have built a word class product having better quality longer durability and cost effectiveness. Smarter technology has become a significant part of our lives. **Amitek** has developed a new breed of "Smart System" , easy to blend in one's class and comfort



## Contents

- Touch Switches (Wifi /Standard)
- Hotel Room Automation Switches
- TV Lift Motor
- Swing Door Motor
- Shutter Motor



## Your Home, Easily Controlled. Intelligently Automated.

We believe home automation should be

-  SIMPLE TO USE
-  AFFORDABLE PRICE
-  EASY TO INSTALL AND MAINTAIN

**Amitek** product range gives you completeness in all above aspects.

## Wi Fi Touch Switches

Wi Fi enabled system can be controlled through smart phones like android and iphone along with IR remote and touch.



**Roller Blinds**

**LED Light Control**

**CURTAIN CONTROL**

**FOOT LIGHT**

# HOME AUTOMATION

Experience the power to control from any place.

# AMITEK SMART HOMES

ONE TOUCH TO EASY, SMART & SECURE LIFE STYLE

LIGHT CONTROL

LIGHT CONTROL

AC CONTROL

CURTAIN CONTROL

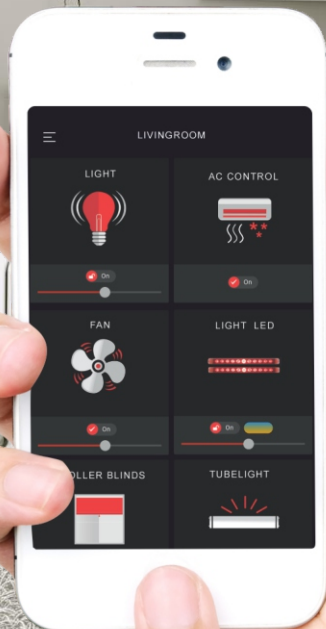

Download on the  
**App Store**



ANDROID APP ON  
**Google play**

# AMITEK

## Touch Switches (WiFi / Standard)

12 Module

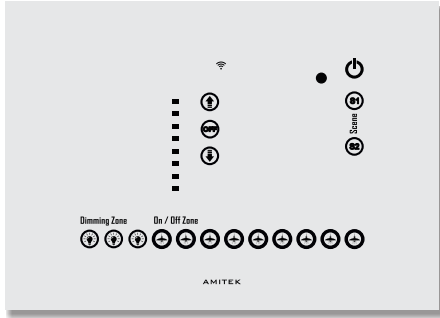

Model No:AWDL-039-W  
AWDL-039-B

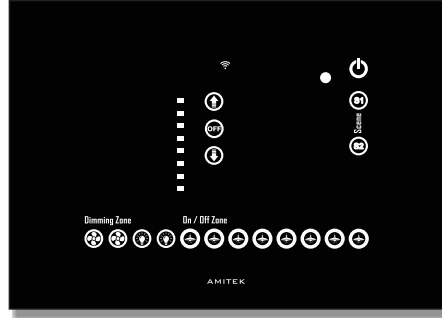

Model No:AWDL-228-W  
AWDL-228-B

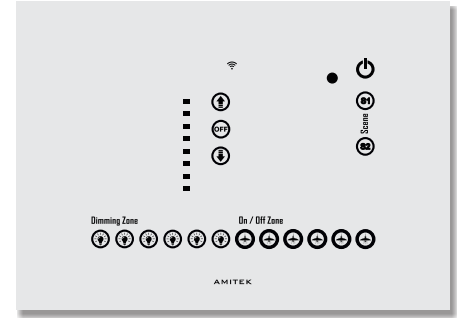

Model No:AWDL-066-W  
AWDL-066-B

### Features

- ✓ Crystal toughened glass
- ✓ WiFi Inbuilt Switch. Control from Mobile apps (Android & iPhone)
- ✓ Capacitive Touch Control
- ✓ IR Remote Control
- ✓ 500 Watt load capacity per point

### Detailed Info

- ✓ WiFi Touch Switches is WiFi inbuilt system which can be operated through mobile apps, IR Remote and Capacitive touch.
- ✓ Crystal toughened glass front finish gives the best looks to blend with any wall design.
- ✓ 4 color shades available Black, White, Gold and Metallic Grey. All colors have its own richness and it's more of your choice according to your wall color.
- ✓ Easily Create and store scene or moods for various occasion from different lights for the best ambient as per the your choice.
- ✓ This is a product for blend of both, class and comfort with energy saving features.

### Technical Info

Model No	Conceal Box Type	Conceal Box Size HxWxD (mm)	Fan Count	Dimmer Count	On/Off Count	Curtain Count	Rated Voltage	Remote Type	Wi Fi Inbuilt
<a href="#">AWDL-039-W</a>	12 Module	145.3 x 215 x 61.2	0	3	9	0	90-240V / 50-60HZ	Infra Red (IR)	Yes
<a href="#">AWDL-228-W</a>	12 Module	145.3 x 215 x 61.2	2	2	8	0	90-240V / 50-60HZ	Infra Red (IR)	Yes
<a href="#">AWDL-066-W</a>	12 Module	145.3 x 215 x 61.2	0	6	6	0	90-240V / 50-60HZ	Infra Red (IR)	Yes
<a href="#">AWDL-039-B</a>	12 Module	145.3 x 215 x 61.2	0	3	9	0	90-240V / 50-60HZ	Infra Red (IR)	No
<a href="#">AWDL-228-B</a>	12 Module	145.3 x 215 x 61.2	2	2	8	0	90-240V / 50-60HZ	Infra Red (IR)	No
<a href="#">AWDL-066-B</a>	12 Module	145.3 x 215 x 61.2	0	6	6	0	90-240V / 50-60HZ	Infra Red (IR)	No

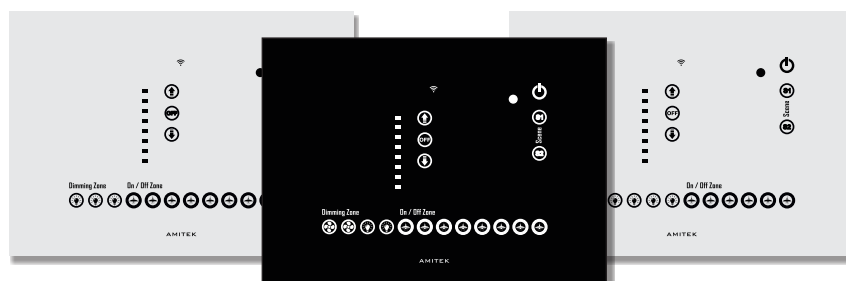

# AMITEK

## Touch Switches (WiFi /Standard)

6 Module

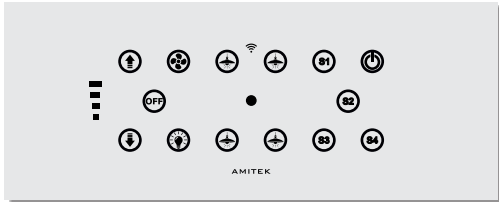

Model No:AWDL-114-W  
AWDL-114-B

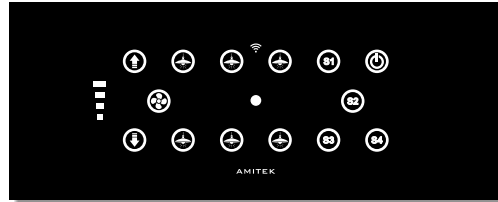

Model No:AWDL-106-W  
AWDL-106-B

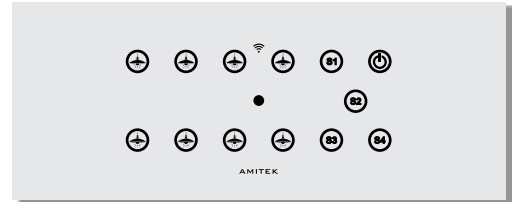

Model No:AWDL-008-W  
AWDL-008-B

### Features

- ✓ Crystal toughened glass
- ✓ WiFi Inbuilt Switch. Control from Mobile apps (Android & iPhone)
- ✓ Capacitive Touch Control
- ✓ IR Remote Control
- ✓ 500 Watt load capacity per point

### Detailed Info

- ✓ WiFi Touch Switches is WiFi inbuilt system which can be operated through mobile apps, IR Remote and Capacitive touch.
- ✓ Crystal toughened glass front finish gives the best looks to blend with any wall design.
- ✓ 4 color shades available Black, White, Gold and Metallic Grey. All colors have its own richness and it's more of your choice according to your wall color.
- ✓ Easily Create and store scene or moods for various occasion from different lights for the best ambient as per the your choice.
- ✓ This is a product for blend of both, class and comfort with energy saving features.

### Technical Info

Model No	Conceal Box Type	Conceal Box Size H x W x D (mm)	Fan Count	Dimmer Count	On/Off Count	Curtain Count	Rated Voltage	Remote Type	Wi Fi Inbuilt
AWDL-114-W	6 Module	76.5 x 214.2 x 51.0	1	1	4	0	90-240V / 50-60HZ	Infra Red (IR)	Yes
AWDL-106-W	6 Module	76.5 x 214.2 x 51.0	1	0	6	0	90-240V / 50-60HZ	Infra Red (IR)	Yes
AWDL-008-W	6 Module	76.5 x 214.2 x 51.0	0	0	8	0	90-240V / 50-60HZ	Infra Red (IR)	Yes
AWDL-114-B	6 Module	76.5 x 214.2 x 51.0	1	1	4	0	90-240V / 50-60HZ	Infra Red (IR)	No
AWDL-106-B	6 Module	76.5 x 214.2 x 51.0	1	0	6	0	90-240V / 50-60HZ	Infra Red (IR)	No
AWDL-008-B	6 Module	76.5 x 214.2 x 51.0	0	0	8	0	90-240V / 50-60HZ	Infra Red (IR)	No

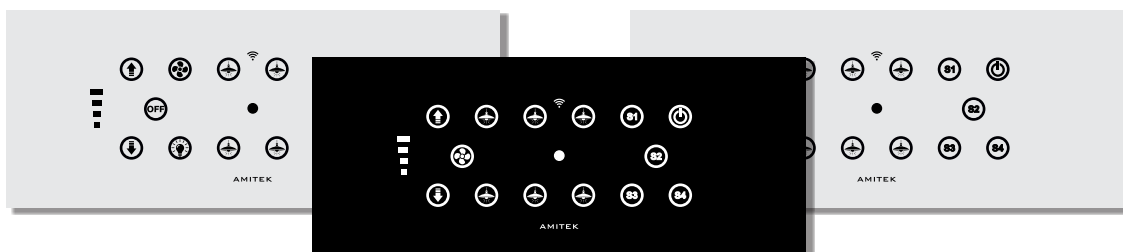

# AMITEK

## Touch Switches (WiFi / Standard)

3 Module



Model No:AWDL-003-W  
AWDL-003-B

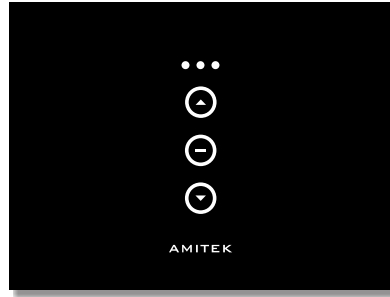

Model No:AWDL-055-W  
AWDL-055-B

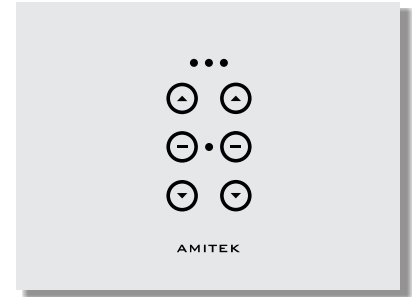

Model No:AWDL-056-W  
AWDL-056-B

### Features

- ✓ Crystal toughened glass
- ✓ WiFi Inbuilt Switch. Control from Mobile apps (Android & iPhone)
- ✓ Capacitive Touch Control
- ✓ IR Remote Control
- ✓ 500 Watt load capacity per point

### Detailed Info

- ✓ WiFi Touch Switches is WiFi inbuilt system which can be operated through mobile apps, IR Remote and Capacitive touch.
- ✓ Crystal toughened glass front finish gives the best looks to blend with any wall design.
- ✓ 4 color shades available Black, White, Gold and Metallic Grey. All colors have its own richness and it's more of your choice according to your wall color.
- ✓ Easily Create and store scene or moods for various occasion from different lights for the best ambient as per the your choice.
- ✓ This is a product for blend of both, class and comfort with energy saving features.

### Technical Info

Model No	Conceal Box Type	Conceal Box Size HxWxD (mm)	Fan Count	Dimmer Count	On/Off Count	Curtain Count	Rated Voltage	Remote Type	Wi Fi Inbuilt
AWDL-003-W	3 Module	76.5 x 99.7 x 51.0	0	0	3	0	90-240V / 50-60HZ	Infra Red (IR)	Yes
AWDL-055-W	3 Module	76.5 x 99.7 x 51.0	0	0	0	1	90-240V / 50-60HZ	Infra Red (IR)	Yes
AWDL-056-W	3 Module	76.5 x 99.7 x 51.0	0	0	0	2	90-240V / 50-60HZ	Infra Red (IR)	Yes
AWDL-003-B	3 Module	76.5 x 99.7 x 51.0	0	0	3	0	90-240V / 50-60HZ	Infra Red (IR)	No
AWDL-055-B	3 Module	76.5 x 99.7 x 51.0	0	0	0	1	90-240V / 50-60HZ	Infra Red (IR)	No
AWDL-056-B	3 Module	76.5 x 99.7 x 51.0	0	0	0	2	90-240V / 50-60HZ	Infra Red (IR)	No

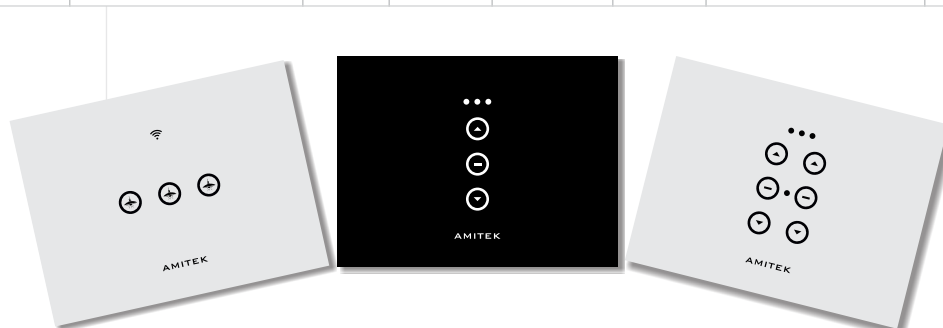



# AMITEK

## Touch Switches (WiFi /Standard)

4 Module

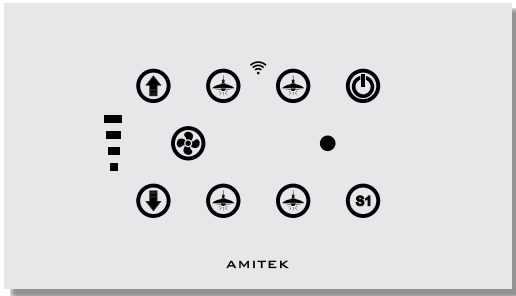

Model No:AWDL-104-W  
AWDL-104-B

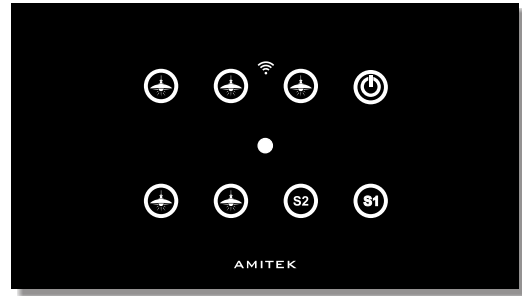

Model No:AWDL-005W  
AWDL-005-B

### Features

- ✓ Crystal toughened glass
- ✓ WiFi Inbuilt Switch. Control from Mobile apps (Android & iPhone)
- ✓ Capacitive Touch Control
- ✓ IR Remote Control
- ✓ 500 Watt load capacity per point

### Detailed Info

- ✓ WiFi Touch Switches is WiFi inbuilt system which can be operated through mobile apps, IR Remote and Capacitive touch.
- ✓ Crystal toughened glass front finish gives the best looks to blend with any wall design.
- ✓ 4 color shades available Black, White, Gold and Metallic Grey. All colors have its own richness and it's more of your choice according to your wall color.
- ✓ Easily Create and store scene or moods for various occasion from different lights for the best ambient as per the your choice.
- ✓ This is a product for blend of both, class and comfort with energy saving features.

### Technical Info

Model No	Conceal Box Type	Conceal Box Size HxWxD (mm)	Fan Count	Dimmer Count	On/Off Count	Curtain Count	Rated Voltage	Remote Type	Wi Fi Inbuilt
AWDL-104-W	4 Module	76.5 x 136.8 x 51.0	1	0	4	0	90-240V / 50-60HZ	Infra Red (IR)	Yes
AWDL-005-W	4 Module	76.5 x 136.8 x 51.0	0	0	5	0	90-240V / 50-60HZ	Infra Red (IR)	Yes
AWDL-104-B	4 Module	76.5 x 136.8 x 51.0	1	0	4	0	90-240V / 50-60HZ	Infra Red (IR)	No
AWDL-005-B	4 Module	76.5 x 136.8 x 51.0	0	0	5	0	90-240V / 50-60HZ	Infra Red (IR)	No

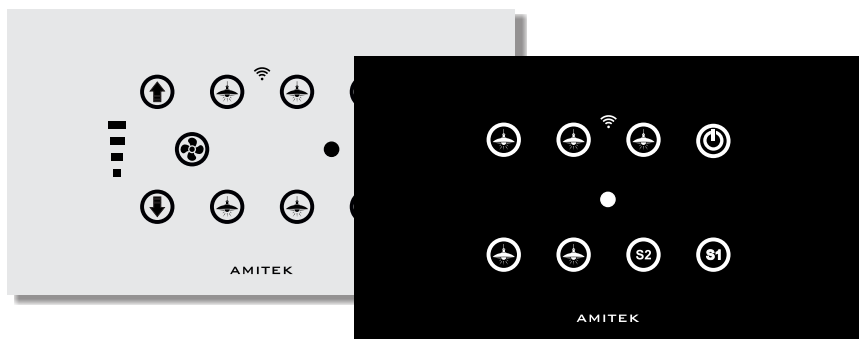

# AMITEK

## Touch Bell Switches (Standard)

2 Module

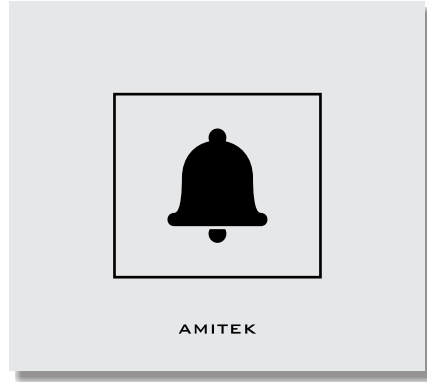

Model No:AWDBS-001-B

### Features

- ✓ Crystal toughened glass
- ✓ Capacitive Touch Control
- ✓ 1 bell point

### Detailed Info

- ✓ Touch bell switch which can be operated through Capacitive touch.
- ✓ Crystal toughened glass front finish gives the best looks to blend with any wall design.
- ✓ 4 color shades available Black, White, Gold and Metallic Grey. All colors have its own richness and it's more of your choice according to your wall color.
- ✓ This is a product for blend of both, class and comfort with energy saving features.

### Technical Info

Model No	Conceal Box Type	Conceal Box Size HxWxD (mm)	Fan Count	Dimmer Count	On/Off Count	Curtain Count	Rated Voltage	Remote Type	Wi Fi Inbuilt
AWDBS-001-B	2 Module	76.5 x 76.5 x 51.0	0	0	1	0	90-240V / 50-60HZ	Infra Red (IR)	No

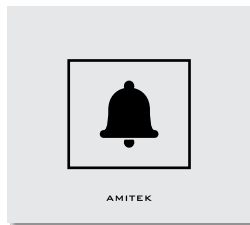

# AMITEK

## Hotel Room Automation

### Indicator Touch Switches



HOTEL CORRIDOR PANEL



HOTEL ACTIVATION PANEL

### Power Saver Switches



KEY CARD PANEL

### Touch Switches for Lighting

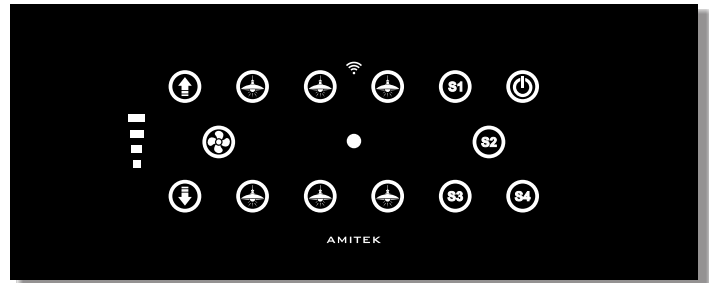
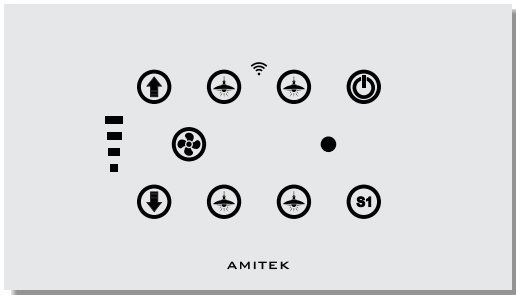

#### Highlights

- ✓ Crystal Glass
- ✓ 1 years warranty
- ✓ Color choice options

#### Features

- ✓ Indicator for MMR, DND & Laundry
- ✓ 500 Watt load capacity per point
- ✓ 230 Volt AC input
- ✓ Power Saver
- ✓ Scene controls

#### Technical Info

MODEL NO	FEATURES	TOUCH TYPE	GLASS SIZE	CUSTOMISE
<a href="#">AWDL-HCP</a>	Corridor Panel 1 Bell button, MMR, DND & Laundry Indication	Capacitive	90*90 mm	OEM & ODM
<a href="#">AWDL-HAP</a>	Hotel Activation Panel for MMR, DND & Laundry Indication	Capacitive	90*90 mm	OEM & ODM
<a href="#">AWDL-HKCP</a>	Key Card Panel for power saving		90*90 mm	OEM & ODM
<a href="#">AWDL-104/AWDL-005</a> <a href="#">AWDL-106/AWDL-008</a>	Light Switches with fan and on/off points	Capacitive	160*90 mm 225*90 mm	OEM & ODM
<a href="#">AWDL-HBP</a>	Single button bathroom panel	Capacitive	90*90 mm	OEM & ODM

# AMITEK

## MOTORS

### TV Lift Motor



Cabinet TV Lift



Bed TV Lift



Ceiling TV Lift

### Features

We provide reliable, ultra quiet, motorized TV lifts that are ideal for industry professionals, commercial and residential. Every TV lift mechanism is manufactured in India and backed by a full 1 year warranty, making it the perfect buy for any professional or individual.

We provide complete media control systems like TV, Set Top Box, music systems etc. can be controlled through mobile apps (Android and iPhone). This is very important in home automation as multiple remote comes in one app and hence very easy to control. Also you can hide set top box and music system and control it through mobile apps.

### Swing Door Motor

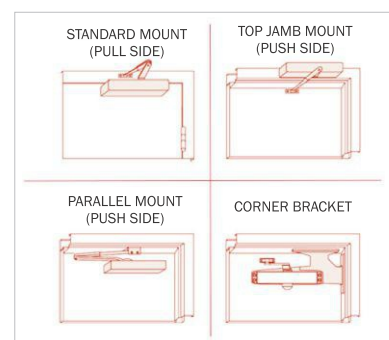
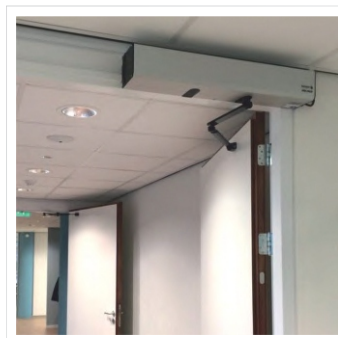

### Automatic Swing Door

We are manufacturer of swing door motor. We provide high quality auto swing door motor, manufactured as per the quality norms. These are ideally used in residential lifts, hospitals, commercial buildings, retail outlets, airports, malls, restaurants etc. Our swing door motor has quality feature like smooth functioning, which ensures zero noise production.

### Features

- ✓ Smooth running without hearable noise
- ✓ Go function makes life safer and easier
- ✓ Open & close the door in 90 Degree
- ✓ Articulated arm and sliding arm both available, can be mounted on the hinge side and opposite hinge side
- ✓ Fully adjustable operating parameters to suit specific applications and numerous control options

**AMITEK**   
**SMART HOMES**  
ONE TOUCH TO EASY, SMART & SECURE LIFE STYLE



**Head office**

148, kasturba nagar, gautam Marg, nirman nagar,  
Jaipur, Rajasthan - 302019

**Demo centre**

Amitek tower, 14/120, main 100 feet Shipra path road,  
Mansarovar, Jaipur, Rajasthan - 302030

 +91-9509119992, +91-9529055557



[sales@amiteksmarthomes.com](mailto:sales@amiteksmarthomes.com) , [support@amiteksmarthomes.com](mailto:support@amiteksmarthomes.com)



[www.amiteksmarthomes.com](http://www.amiteksmarthomes.com)