

AMITEK ENTER THE ERA OF VOICE RECOGNITION

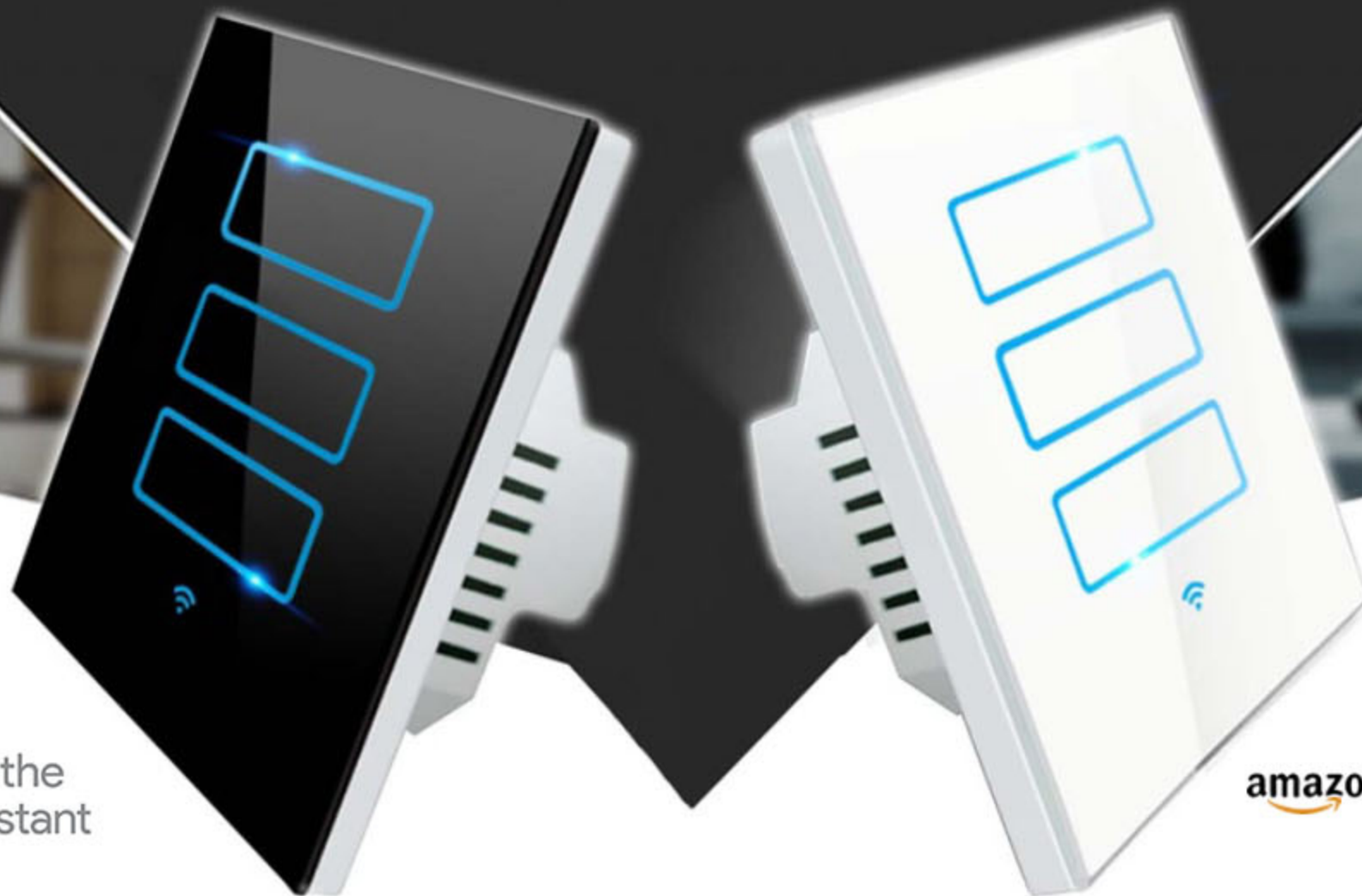

 works with the Google Assistant

 works with the Amazon Assistant

AMITEK SMART WIFI SWITCH

-  No host sever
-  Scene mode
-  Two color design
-  Big touch key design
-  DIP design
-  Separate glass panel
-  Mobile phone control
-  1 button to search all
-  Timing function
-  Remote control
-  Universal back design
-  Non-brass terminal

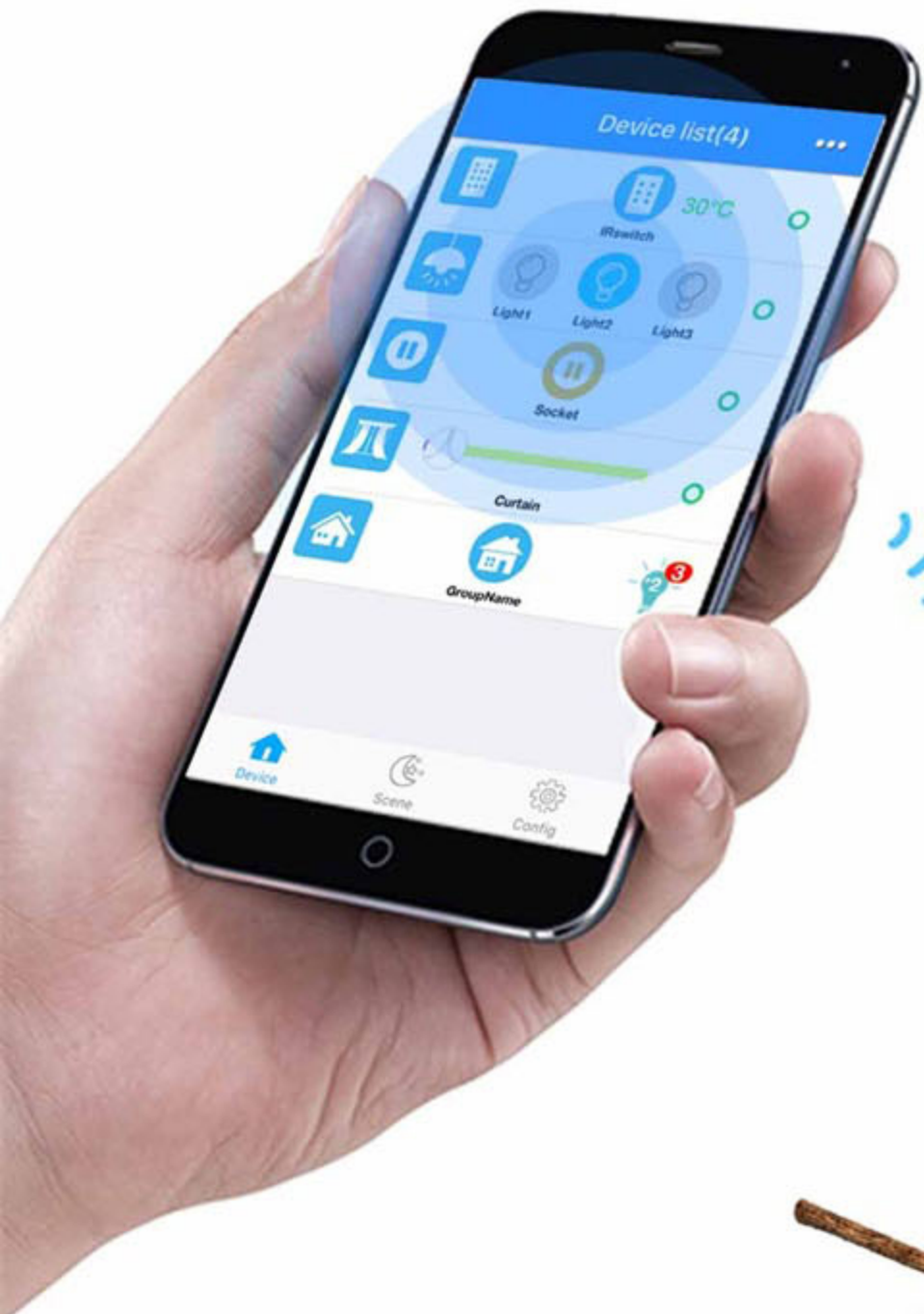

Mobile phone control directly No host sever

Unique touch design on app and glass panel, two color design, big button ,creat a comfortable, simple, humanized light control.



Built-in
wifi module



Do not need host sever ,
only buy one switch can be used.

Mobile phone one key configuration

Setting easy, everyone know how to control. Two-way design, Each operation wil show on both mobie phone and switch. Control stable and reliable.



Wiring Diagram

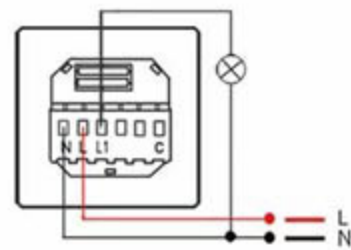

Dimmer Switch

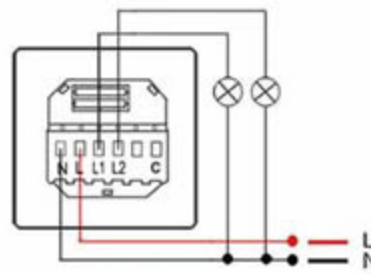

Light Switch

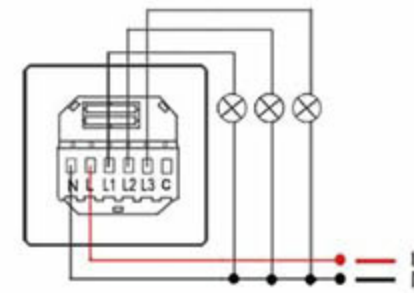

Light Switch

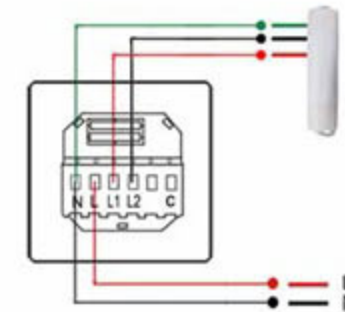

Curtain Switch

More Stable wifi signal

Adopt mature and stable wifi technology, Signal is stable and reliable, easily extended ,cover everywhere, If the signal is bad weak, add a wifi repeater to solve it.

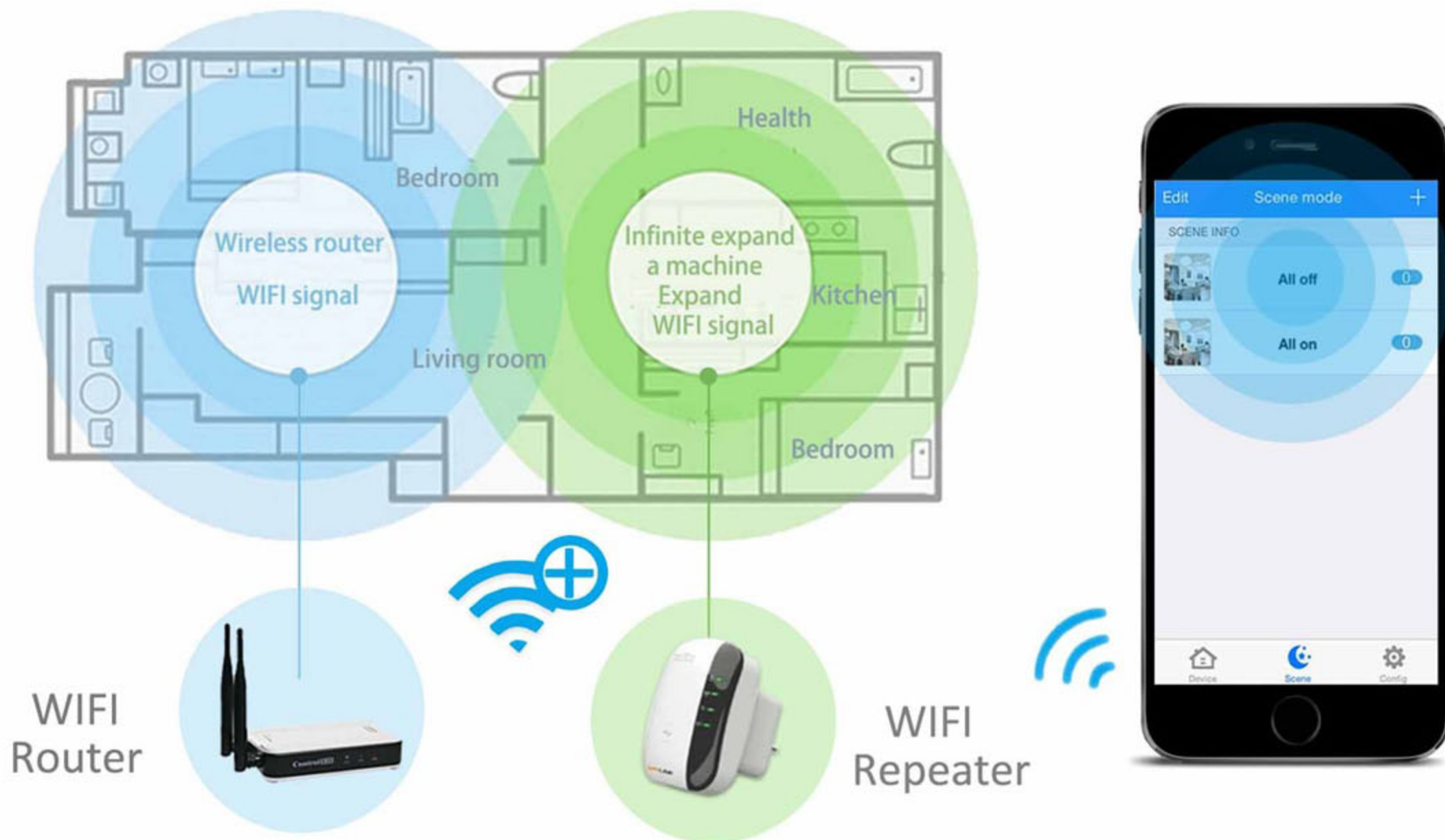

Unique Room Classification System

Unique Room classification system, user can classify the device as they want, you can classify according to different room or different devices. With the concisely design and humanity operation, the status of device can be seen on the phone. Moreover, you can on/off all device with one key operation.

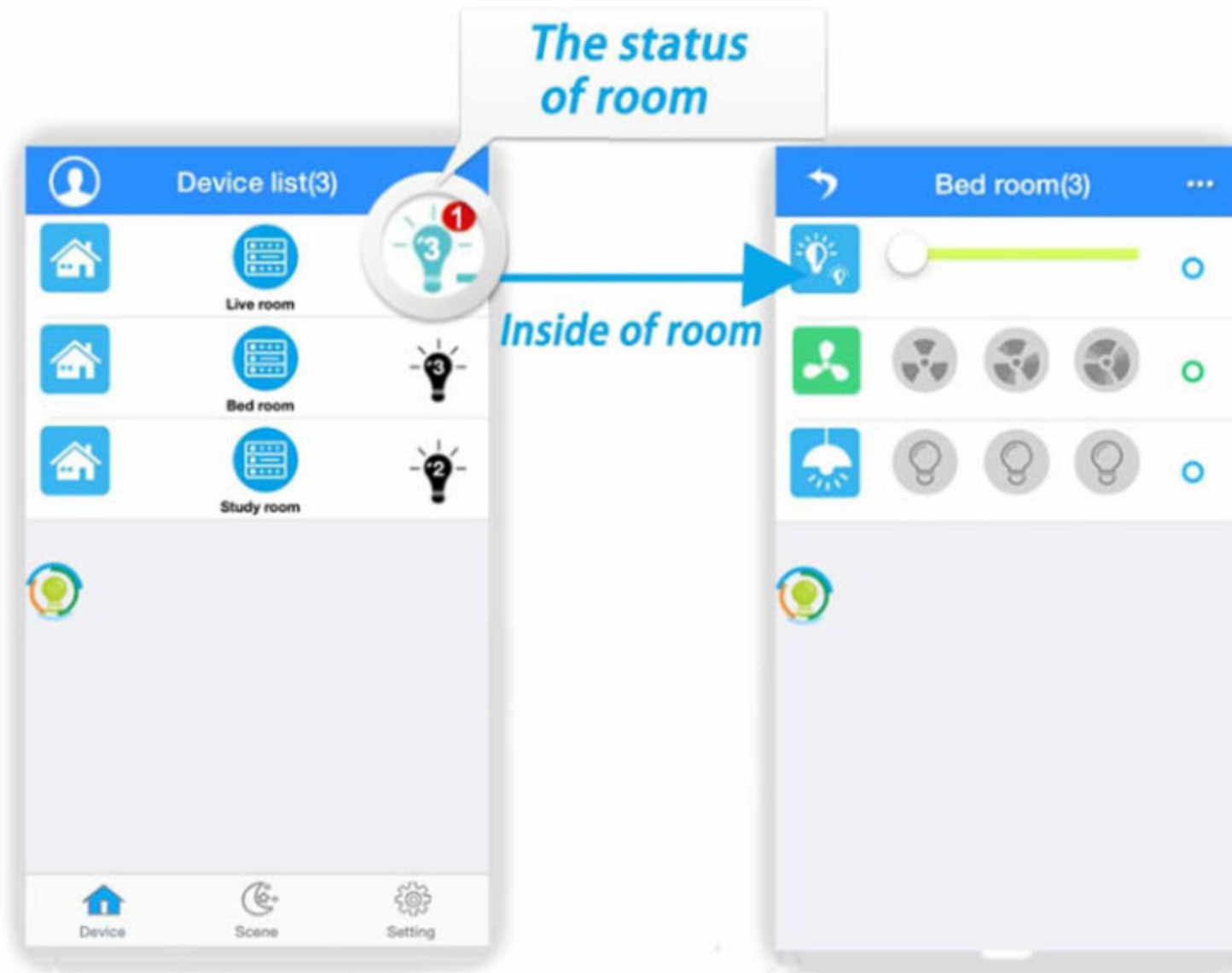

Completed Smart Home System

We have Professional R&D team, mature technology and completed system including light, curtain, socket, IR repeater ,dimmer, fan, camera, doorbell .They are satisfied with using for all family.



Timing function

Automatically open the light in the morning, and wake you up.





Remote Control open device in advance

When you come back home at night, open the light in advance, warm light waiting for your back.



Powerful scene mode

Away Home

At Home

Click "away home" to close all the light

Click at home to open all the light



Set scene mode,
one key to on/off all the switch

Unique DIP Design

1 switch + 4 glass panel = 1 gang switch + 2 gang switch + 3 gang switch + curtain switch



Instruction



Encode structure

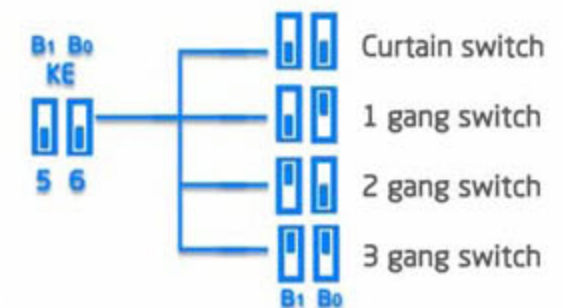
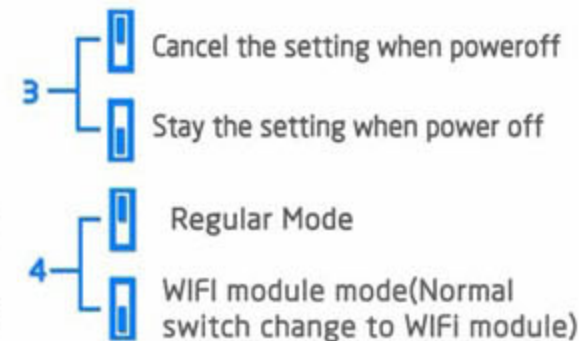
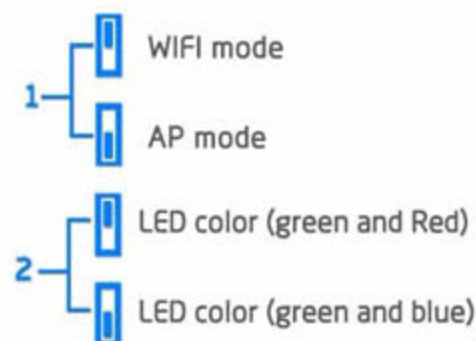

4 switches change freely No more trouble for storing goods

The only switch in the world, which integrate 1 gang/2 gang/ 3 gang and curtain switch into one WIFI smart switch, only need to buy one switch, can bring 4 functions switch back home.



1 switch + 4 glass panel = 1 gang + 2 gang + 3 gang + curtain

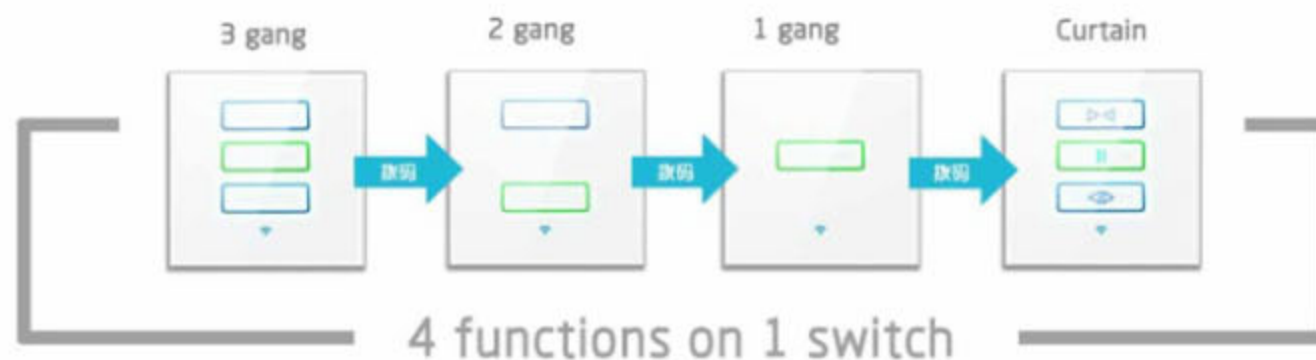

Normal switch to smart switch

Turn the WIFI switch to WIFI model and hide it in the wall.



Connect with

normal switch



After switching,
it will turn a normal
switch to a WIFI switch

The only switch in the world,
which can switch the WIFI model and turn normal switch to a WIFI switch.

Keep innovation and high technology

High quality and security

PC Fire-retardant material

Fire proof and safe

Universal back design

Suitable for both round
and square back install boxes

Non-Brass material

More security and stable

DIP design

4 functions on 1 switch

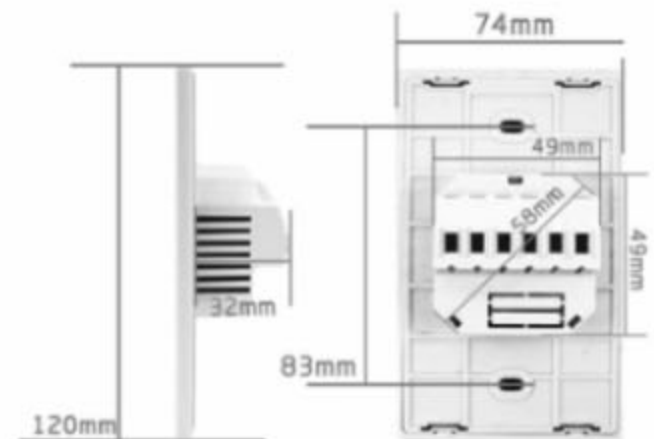
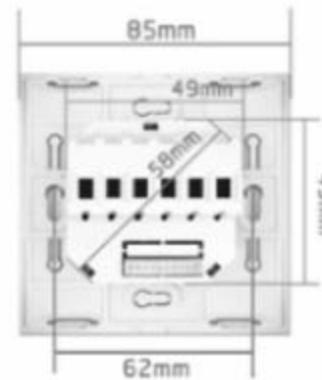
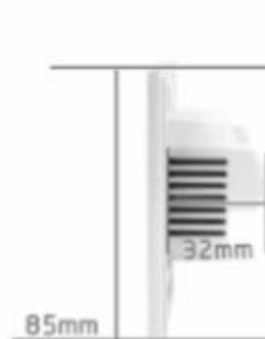
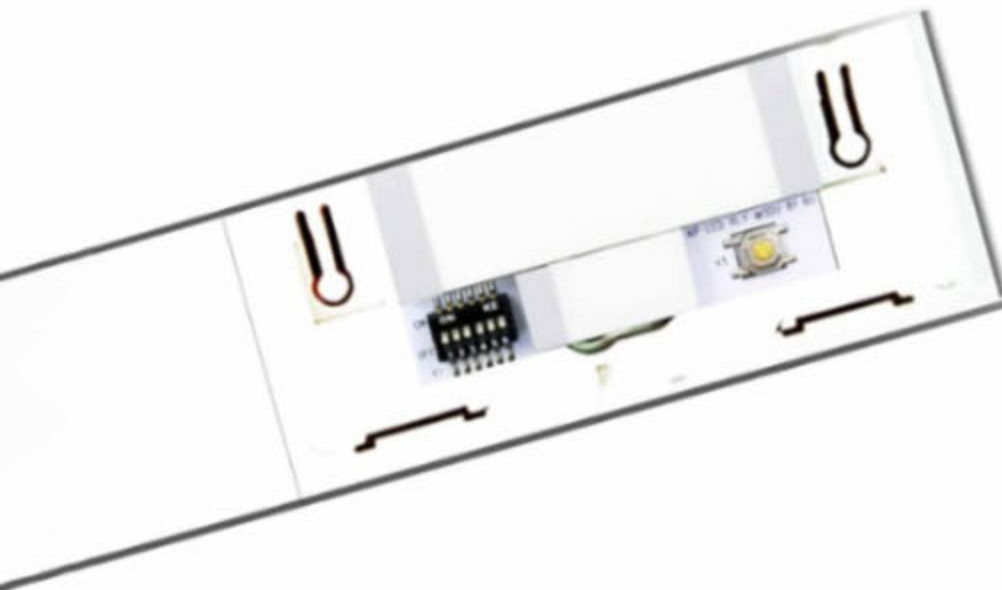

Back size picture



AC/TV/SET TOP BOX CONTROLLING

WI-FI Smart Infrared Repeater

Mobile phone universal remote

-  Remote Control
-  One key configuration
-  Scene mode



Remote Control

Turn on the air condition anywhere and anytime

Support 99.99% of air condition on the market.

Download APP software by mobile phone,remote control your home appliances.
Turn on air condition by App remotely in advance, you can enjoy comfortable and cool environment when you back home in the hot summer day.



Scene Mode

Cinema Mode Touch and enjoy

Normally, Turn on the home cinema need to turn on several devices and switch many remote, complex and trouble. Using scene mode, only need one time setting, then you can turn on home cinema with one key. even Old and children know how to use it .

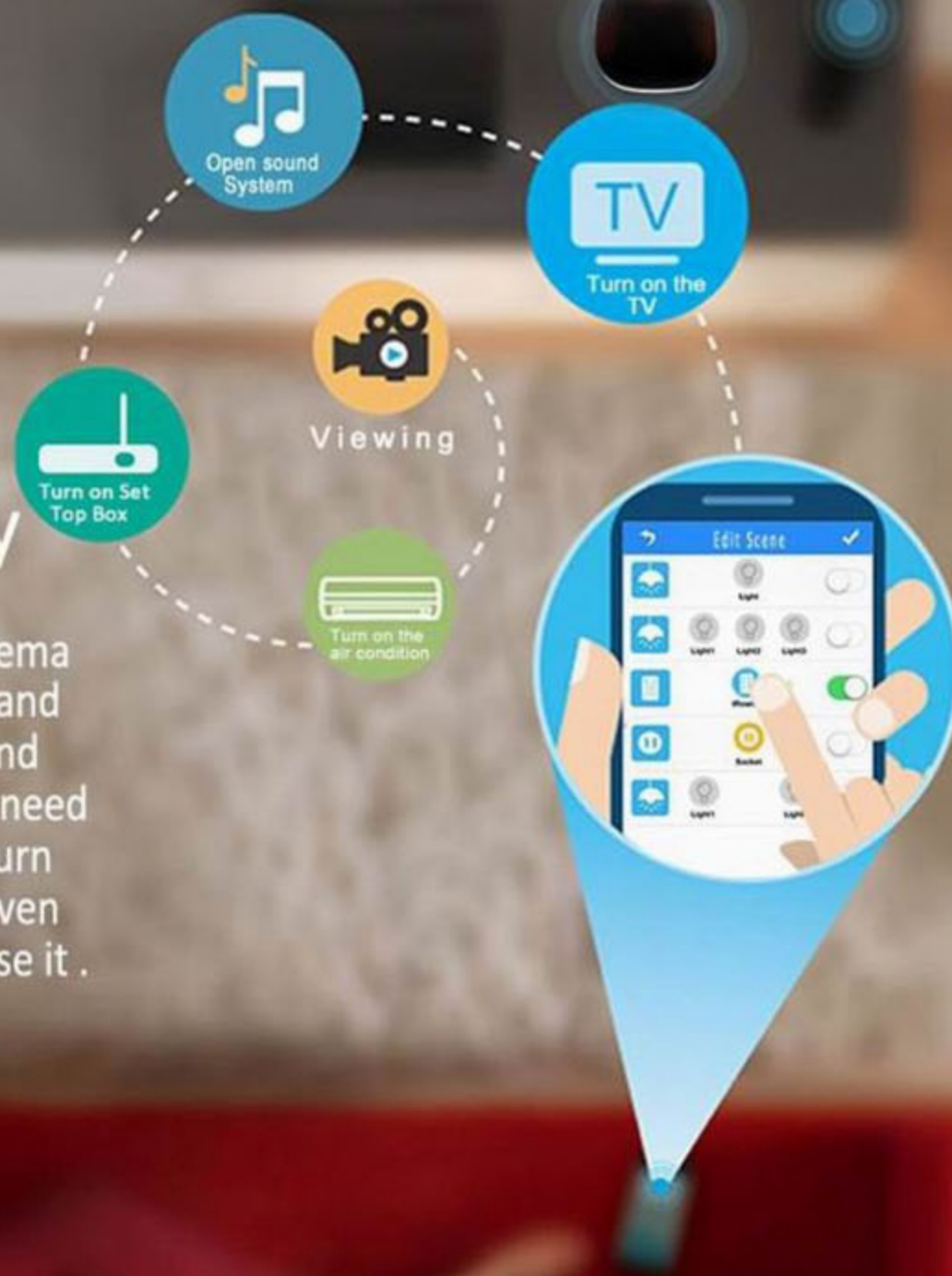

Variety Of Interface

Mobile phone can replace a variety of remote controller, control the electrical appliance via android APP and IOS.

WIFI smart IR include the AC. TV. STB DVD , Audio control interface. also have the customize control interface, can learn all the IR control signal.

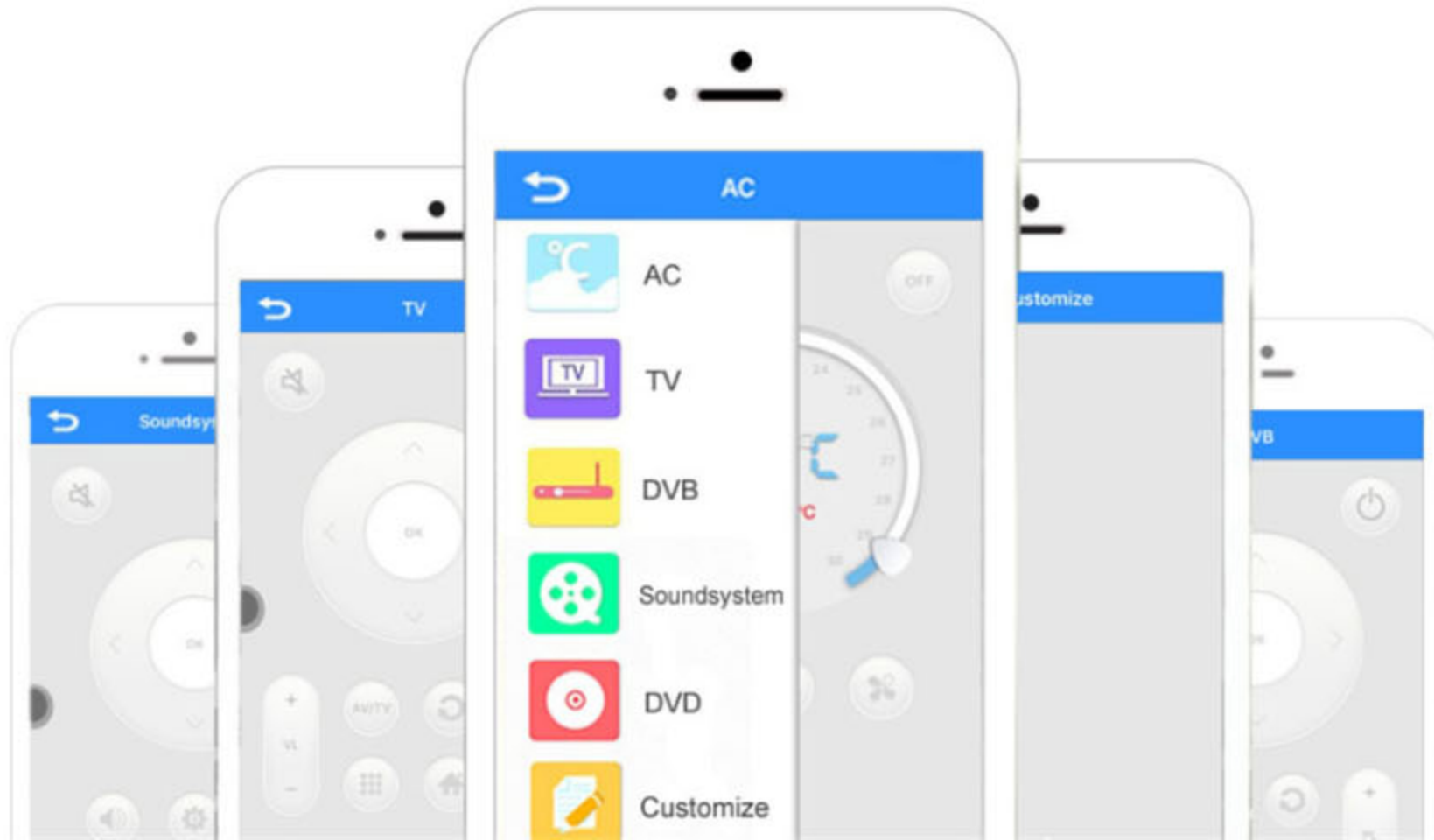

Match May Brands

No more trouble for matching
It can match **over 5000+** electrical appliances



One key setting No more trouble for using

One key configuration function let smart IR connect to the internet quickly .
input wifi password . rapidly connect with wifi network.



Select wifi and input password

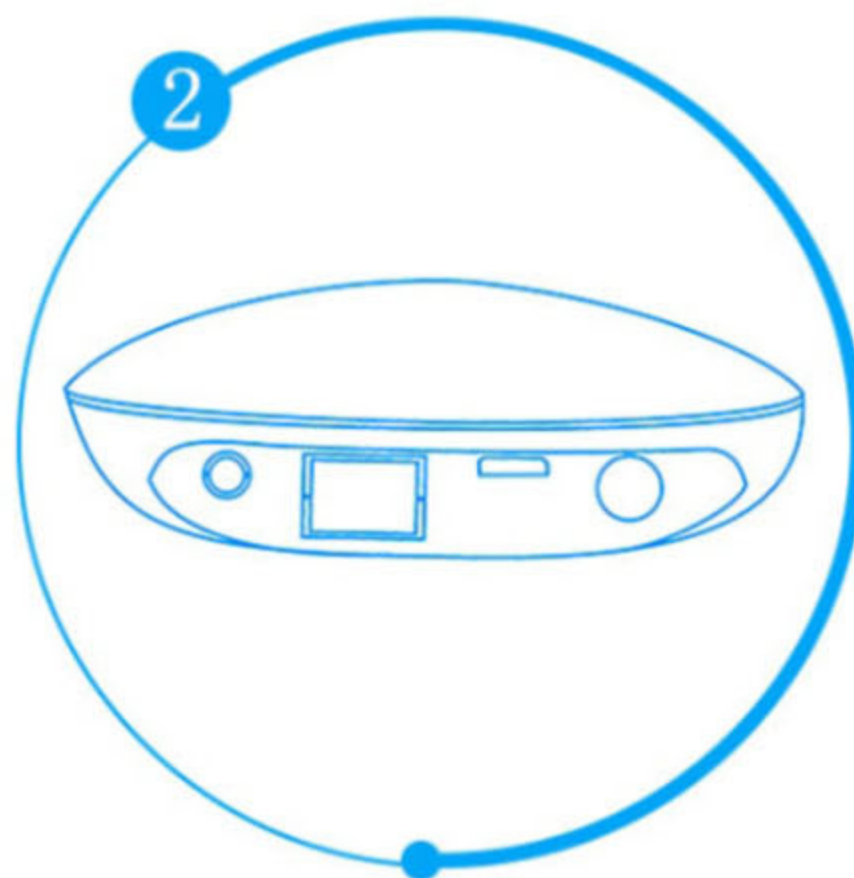

Indicator light keeps on mean configuration finished

Reject batteries protect the environment

Replace battery for remote was money wasting and cause environment pollution,
Smart IR use USB cable to connect the power supply,
more convenient and save much power.

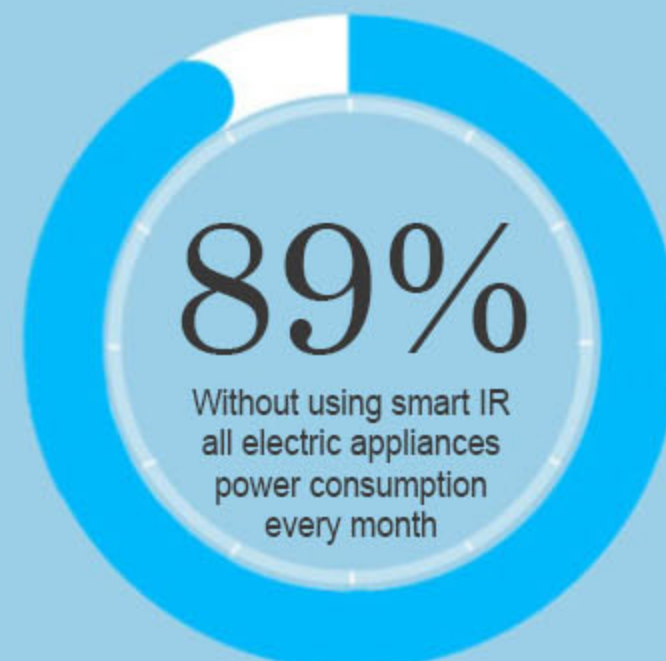
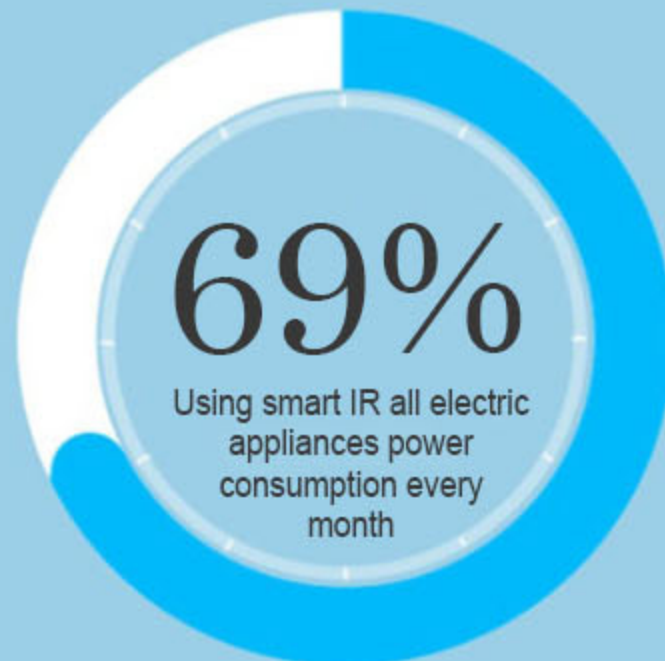
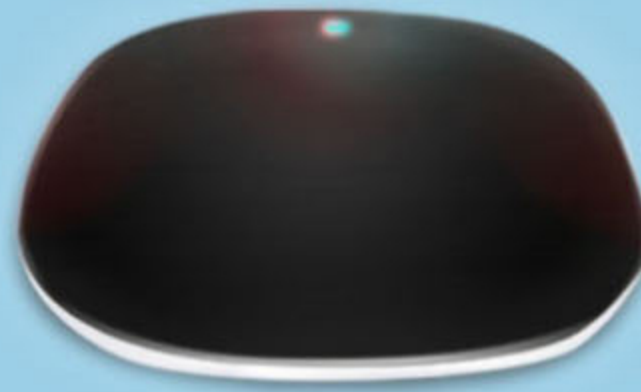
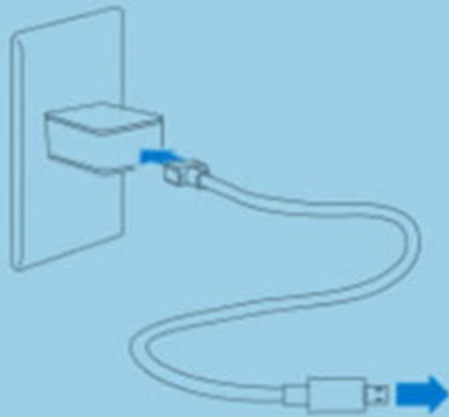

Can hang on the wall humanize design

Retardant material back, you can hang
smart IR on the wall through the bottom groove.

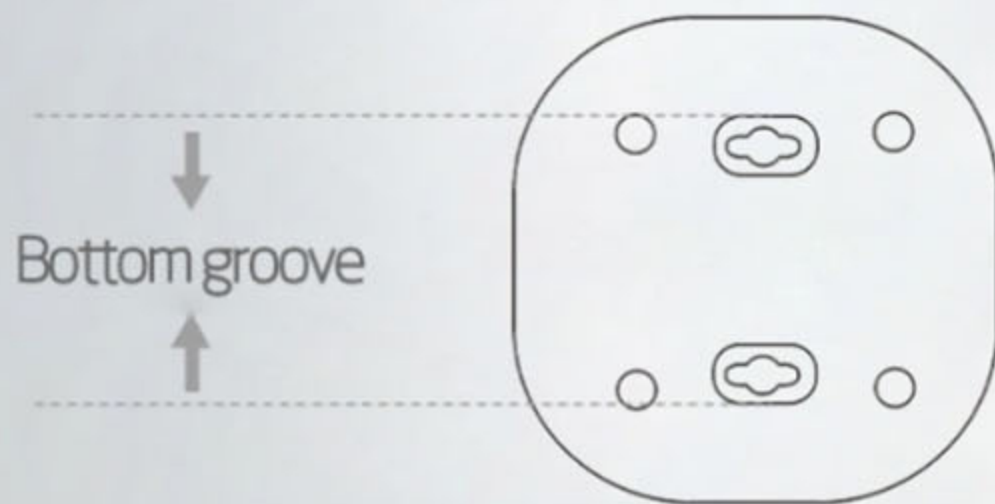

AMITEK SMART HOMES



www.amiteksmarthomes.com